

CLAIRE

C031

Standard features

- Frame: wooden structure, seat suspensions in reinforced elastic webbing.
- Paddings in eco-friendly open cell polyurethane foam, with different densities.
- Covering in leather or fabric. Not removable coverings. - All the versions marked by the symbol "↑" are equipped with manual adjustable headrest.
- Legs in Gunmetal (Cod.50), Antique Bronze (Cod.52).
- Versions Cod.1421- 1422 - 1671 - 1672 - 3031 - 3032 with top in marble Emperador (Cod.EM) or White Carrara marble (Cod.CA).
- Stitching type cod.06 for leather covering for the top of the seat cushion. Stitching type cod.03 for the other parts.
- Stitching type cod.03 for fabric covering.
- Folding bed not available.
- Sectional sides are finished.

Optional features available upon request with no upcharge

- Stitching, unless differently requested, will be matching the leather or fabric colour. Contrast stitching colour can be ordered at no extra charge. You might use as reference any Nicoline leather.

Optional features available upon request with an upcharge

- External panel of the armrest frame with a different covering from the rest of the sofa (Config. 1).
- 7% upcharge for combined coverings (except for the armrest panel which has dedicated upcharge). Please refer to the NOTES at the beginning of pricelist.

Notes

- Versions with asterisk (*) have always the terminal side finished with the possibility to be connected to modular elements.
- Different stitchings not available.
- **For some fabrics and velvets production dept. must apply the stitching Cod.00 / Cod.03 (as per picture below).**

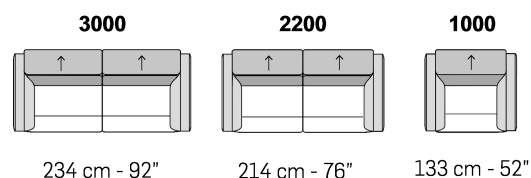
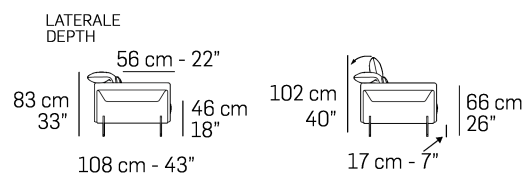
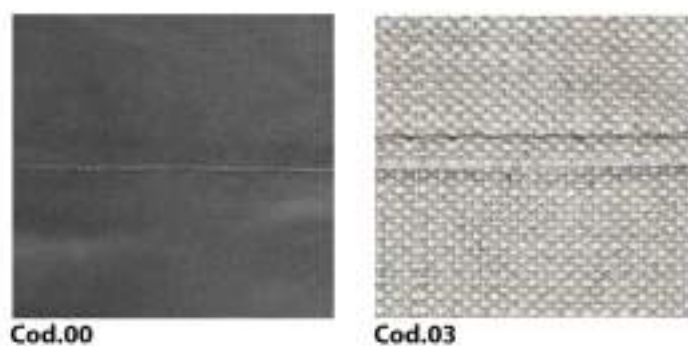

A ↓ all items in group A have the same seat width

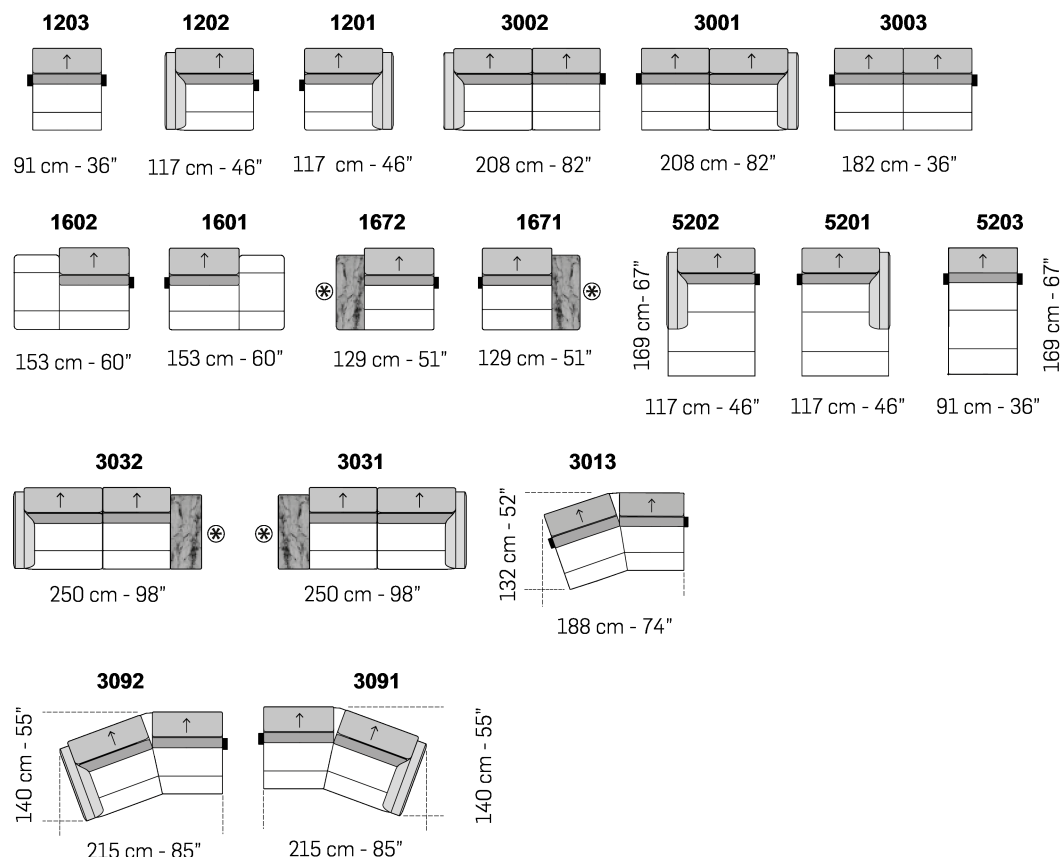

B ↓ all items in group B have the same seat width

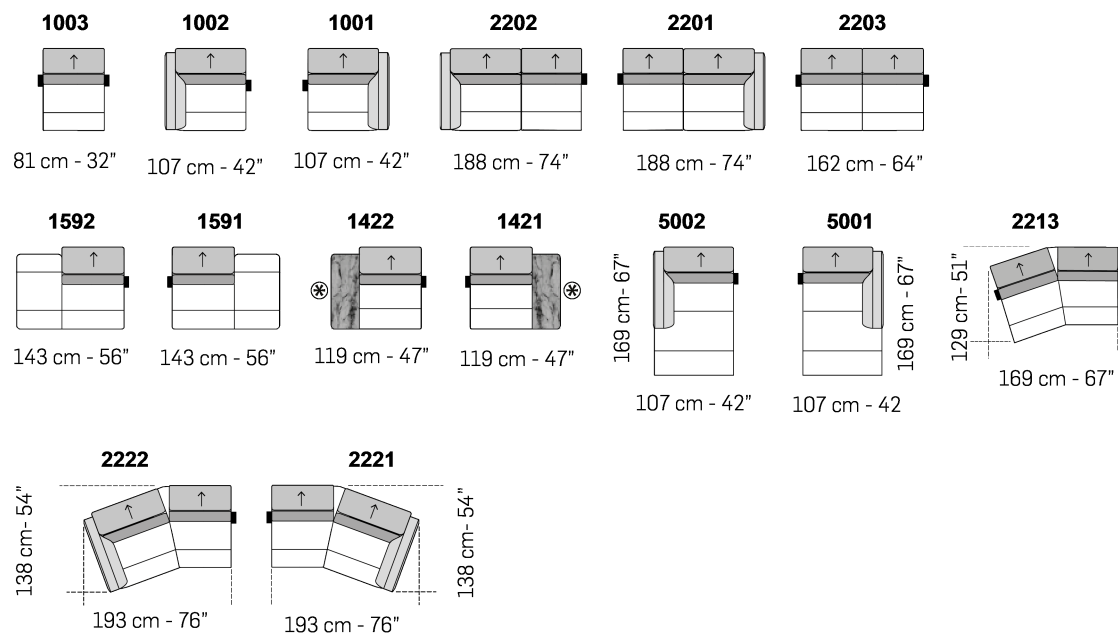

↓ These elements are compatible with all groups of versions



Config.1

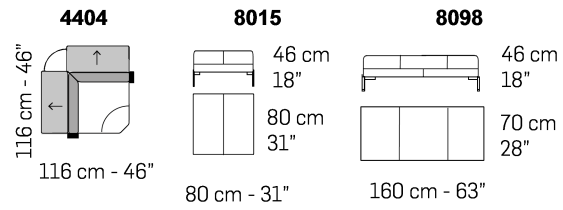

Scala 1:100
Ratio 1 to 100

Legenda / Legend

- Spalliera / Back Cushions
- Bracciolo / Armrest
- Marmo / Marble
- Poggiareni / Kidneyrest
- Seduta / Seat Cushions
- ↑ Poggiatesta regolabile / Adjustable headrest
- ⊗ Lato terminale sempre rifinito e agganciabile agli elementi componibili / Terminal side is always finished and it can also be connected to modular elements
- Aggancio Componibile / Connector

Note / Notes

Nicoline si riserva il diritto di apportare in ogni momento modifiche tecniche ed estetiche / Nicoline reserves the right to change, at any time and without prior warning, technical and aesthetic specifications of the articles.

SUGGESTED COMPOSITIONS (Optional accessories are not included in the price reported in the image)

Cod. 3000

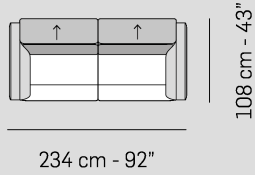

FABRIC - Cat. D

LEATHER - Cat. 2000

€ 4.041

€ 4.923



Cod. 3032 + 5201

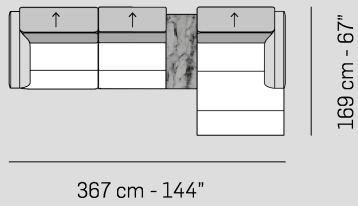

FABRIC - Cat. D

LEATHER - Cat. 2000

€ 7.352

€ 8.744



Cod. 3002 + 4404 + 1601

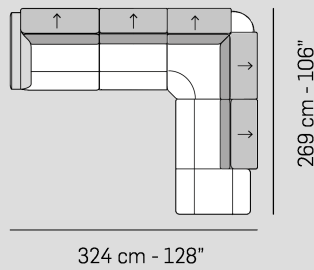





FABRIC - Cat. D

LEATHER - Cat. 2000

€ 9.122

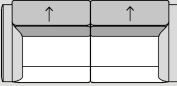
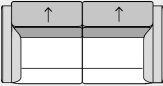
€ 10.858



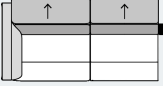
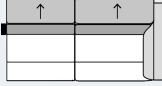
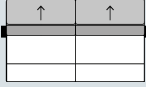

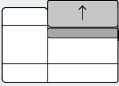
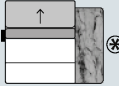
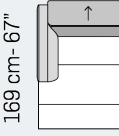
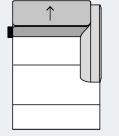
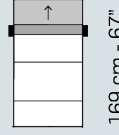
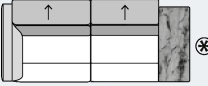
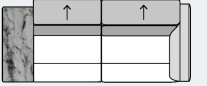
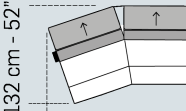
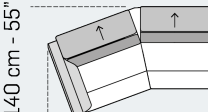
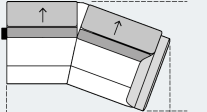
PRICE LIST (€ - EUR)	LEATHER						CUSTOM COVER	FABRIC			Cover mt Weight kg Volume m³
	CAT. 2000	CAT. 2500	CAT. 3000	CAT. 3500	CAT. 4000	CAT. 5000		CAT. D	CAT. G	CAT. H	
3000 - 3 seater  234 cm - 92" Combined covering Config. 1 + 432	€ 4.923	5.254	5.648	6.309	6.706	7.232	4.055	4.041	4.668	5.116	10,90 92 1,67
2200 - 2 str maxi  214 cm - 76" Combined covering Config. 1 + 432	€ 4.684	4.993	5.364	5.982	6.354	6.848	3.893	3.884	4.505	4.949	10,70 84 1,53
1000 - armchair  133 cm - 52" Combined covering Config. 1 + 432	€ 3.200	3.411	3.663	4.082	4.334	4.668	2.672	2.662	3.071	3.364	7,10 55 0,95
A ↓ all items in group A have the same seat width											
1203 - armless maxi chair  91 cm - 36"	€ 2.186	2.322	2.479	2.747	2.904	3.119	1.862	1.849	2.104	2.287	4,40 33 0,65
1202 - maxi armchair 1 lhf arm / 1201 - maxi armchair 1 rhf arm   117 cm - 46" 117 cm - 46" Combined covering Config. 1 + 216	€ 2.759	2.936	3.147	3.503	3.714	3.997	2.302	2.287	2.611	2.844	5,70 46 0,83
3002 - 3str 1 lhf arm / 3001 - 3str 1 rhf arm   208 cm - 82" 208 cm - 82" Combined covering Config. 1 + 216	€ 4.445	4.731	5.078	5.651	5.994	6.454	3.698	3.676	4.221	4.608	9,50 80 1,48
3003 - armless 3str  182 cm - 36"	€ 3.556	3.749	3.978	4.363	4.596	4.905	3.109	3.074	3.471	3.755	8,30 67 1,30

PRICE LIST (€ - EUR)	LEATHER						CUSTOM COVER	FABRIC			Cover mt Weight kg Volume m ³		
	CAT.	CAT.	CAT.	CAT.	CAT.	CAT.		CAT.	CAT.	CAT.			
	2000	2500	3000	3500	4000	5000		D	G	H			
1602 - armless maxi chair lhf term. / 1601 - armless maxi chair rhf term.													
 153 cm - 60"	 153 cm - 60"	€	3.137	3.314	3.525	3.878	4.089	4.369	2.703	2.668	2.996	3.229	5,80 51 1,09
1672 - armless maxi chair lhf marble term. / 1671 - armless maxi chair rhf marble term.													
 129 cm - 51"	 129 cm - 51"	€	2.933	3.074	3.245	3.528	3.698	3.925	2.609	2.558	2.822	3.008	4,60 51 0,92
5202 - cl maxi 1 lhf arm / 5201 - cl maxi 1 rhf arm													
 169 cm - 67" 117 cm - 46"	 117 cm - 46"	€	3.600	3.815	4.073	4.505	4.763	5.106	3.033	2.999	3.383	3.657	6,80 66 1,31
Combined covering Config. 1 + 216													
5203 - armless cl maxi													
 169 cm - 67" 91 cm - 36"		€	2.952	3.119	3.317	3.648	3.849	4.114	2.547	2.514	2.819	3.040	5,40 55 1,02
3032 - 3str 1 lhf arm marble term. / 3031 - 3str 1 rhf arm marble term.													
 250 cm - 98"	 250 cm - 98"	€	5.144	5.440	5.793	6.385	6.738	7.214	4.403	4.353	4.917	5.320	9,70 90 1,78
Combined covering Config. 1 + 216													
3013 - armless 3str trapezium													
 132 cm - 52" 188 cm - 74"		€	4.196	4.438	4.728	5.213	5.503	5.887	3.612	3.575	4.048	4.388	8,30 74 1,64
3092 - 3str 1lhf arm trapezium / 3091 - 3str 1rhf arm trapezium													
 140 cm - 55" 215 cm - 85"	 140 cm - 55" 215 cm - 85"	€	4.794	5.081	5.424	5.994	6.338	6.795	4.058	4.023	4.564	4.955	9,50 87 1,99
Combined covering Config. 1 + 216													

B ↓

all items in group B have the same seat width

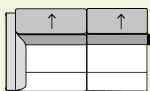
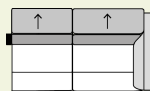
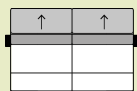
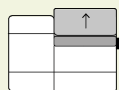
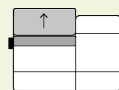
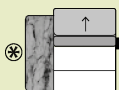
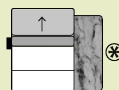
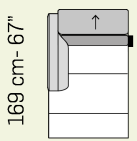
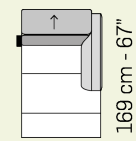
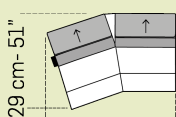
PRICE LIST (€ - EUR)	LEATHER						CUSTOM COVER	FABRIC			Cover mt Weight kg Volume m³	
	CAT.	CAT.	CAT.	CAT.	CAT.	CAT.		CAT.	CAT.	CAT.		
	2000	2500	3000	3500	4000	5000		D	G	H		
1003 - armless chair  81 cm - 32"	€	2.076	2.199	2.344	2.589	2.737	2.933	1.806	1.796	2.057	2.246	4,60 29 0,58
1002 - armchair 1 lhf arm / 1001 - armchair 1 rhf arm   107 cm - 42" 107 cm - 42" Combined covering Config. 1 + 216	€	2.643	2.807	3.005	3.336	3.534	3.796	2.232	2.218	2.539	2.766	5,70 42 0,76
2202 - 2str maxi 1 lhf arm / 2201 - 2str maxi 1 rhf arm   188 cm - 74" 188 cm - 74" Combined covering Config. 1 + 216	€	4.130	4.394	4.716	5.245	5.563	5.988	3.483	3.468	4.007	4.391	9,40 71 1,34
2203 - armless 2str maxi  162 cm - 64"	€	3.295	3.471	3.682	4.035	4.246	4.527	2.917	2.889	3.279	3.560	8,20 58 1,15
1592 - armless chair lhf term. / 1591 - armless chair rhf term.   143 cm - 56" 143 cm - 56"	€	3.005	3.172	3.371	3.701	3.900	4.167	2.620	2.586	2.914	3.147	5,80 47 1,02
1422 - armless chair lhf marble term. / 1421 - armless chair rhf marble term.   119 cm - 47" 119 cm - 47"	€	2.822	2.952	3.112	3.374	3.531	3.742	2.550	2.507	2.775	2.967	4,70 47 0,85
5002 - cl 1 lhf arm / 5001 - cl 1 rhf arm   169 cm - 67" 169 cm - 67" 107 cm - 42" 107 cm - 42" Combined covering Config. 1 + 216	€	3.437	3.638	3.881	4.287	4.530	4.854	2.927	2.898	3.279	3.556	6,80 62 1,18
2213 - armless 2str maxi trapezium  129 cm - 51" 169 cm - 67"	€	3.960	4.183	4.448	4.889	5.153	5.506	3.480	3.452	3.931	4.275	8,40 65 1,44

PRICE LIST (€ - EUR)	LEATHER						CUSTOM COVER	FABRIC			Cover mt Weight kg Volume m ³	
	CAT.	CAT.	CAT.	CAT.	CAT.	CAT.		CAT.	CAT.	CAT.		
	2000	2500	3000	3500	4000	5000		D	G	H		
<p>2222 - 2str maxi 1lhf arm trapezium / 2221 - 2str maxi 1rhf arm trapezium</p> <p>138 cm - 54" 193 cm - 76" 138 cm - 54" 193 cm - 76"</p> <p>Combined covering Config. 1 + 216</p>	€	4.536	4.801	5.119	5.648	5.966	6.388	3.897	3.865	4.410	4.797	9,40 78 1,76

↓ These elements are compatible with all groups of versions

<p>4404 - open square corner</p> <p>116 cm - 46" 116 cm - 46"</p>	€	3.276	3.471	3.704	4.092	4.325	4.637	2.798	2.778	3.175	3.459	6,90 58 0,89
--	---	-------	-------	-------	-------	-------	-------	-------	-------	-------	-------	--------------------

<p>8015 - square footstool</p> <p>46 cm 18" 80 cm 31" 80 cm - 31"</p>	€	1.169	1.222	1.288	1.395	1.458	1.544	1.082	1.062	1.178	1.260	2,10 18 0,19
--	---	-------	-------	-------	-------	-------	-------	-------	-------	-------	-------	--------------------

<p>8098 - maxi rectangular footstool</p> <p>46 cm 18" 70 cm 28" 160 cm - 63"</p>	€	1.928	2.054	2.205	2.457	2.608	2.810	1.687	1.688	1.975	2.183	5,00 28 0,32
---	---	-------	-------	-------	-------	-------	-------	-------	-------	-------	-------	--------------------